

# ACCESSORY



# SUNSHADE INSTRUCTION

3010-9027

**Canopy**

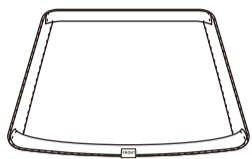

1 pc

**Frame**

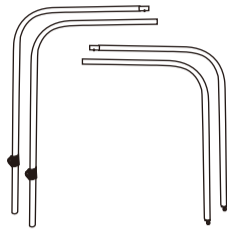

4 pc

**Tube**



2 pc

**Straps**



2 pc

**U-Bolt**



2 pc

**Washer**



4 pc

**Hexagonal Nut**



4 pc

**Hexagonal Nut**



4 pc

**Bolt**



2 pc

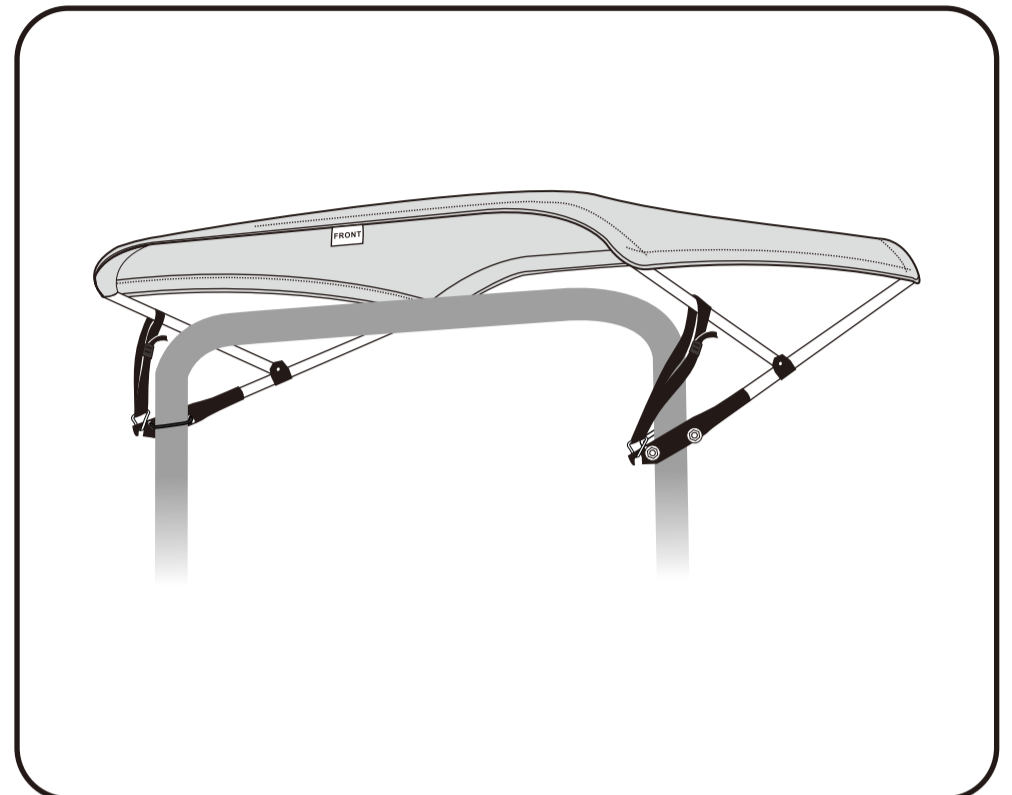

**PLEASE NOTE:**

REMOVE SUNSHADE PRIOR TO TRANSPORT, COULD RESULT IN SERIOUS DAMAGE TO SUNSHADE.

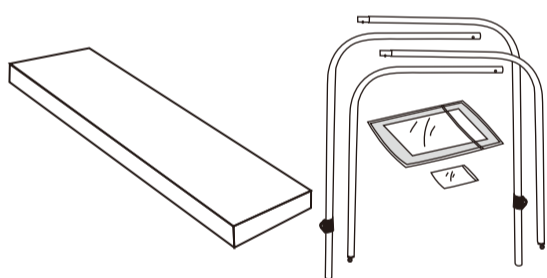

1. Take out full set SUNSHADE PARTS

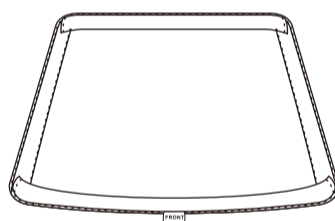

2. Lay fabric flat upside-down

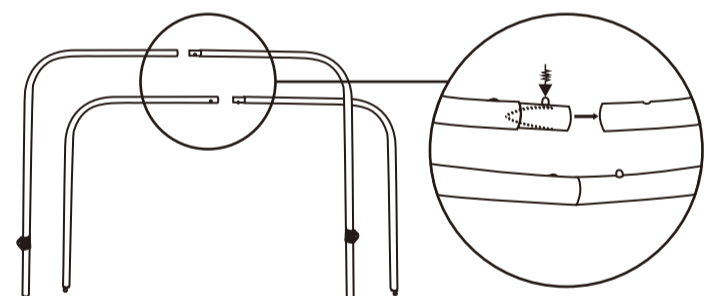

3. Snap connector

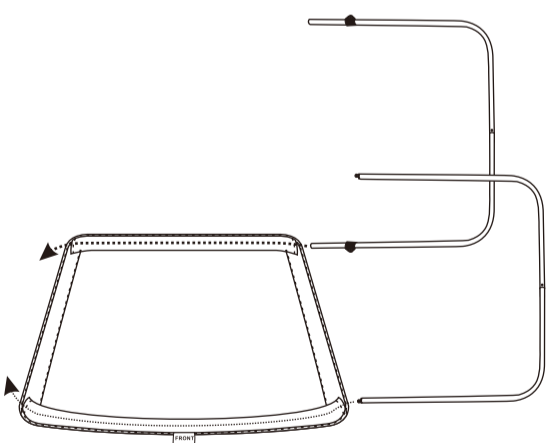

4. Insert the frame into the fabric sleeves

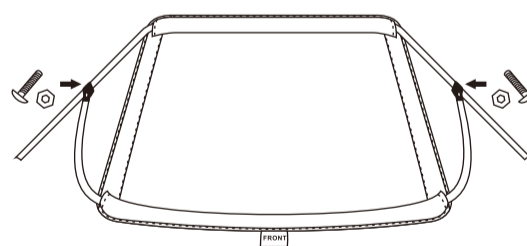

5. Use Bolt and nut fix the short frame to long frame



6. Use U-Bolt to fix Black frame

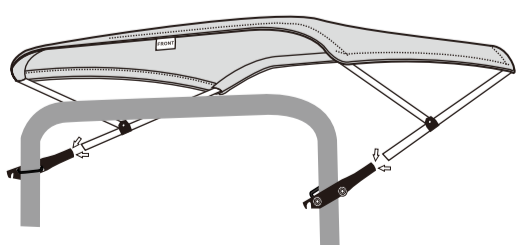

7. Inset sunshade frame to Black tube

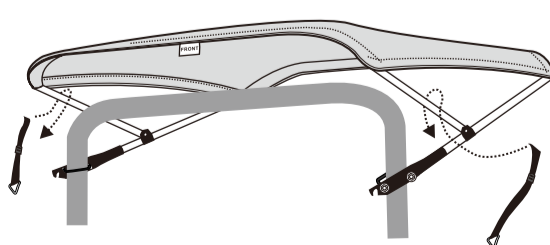

8. Fix the straps to frame, fix it to Black tube

